

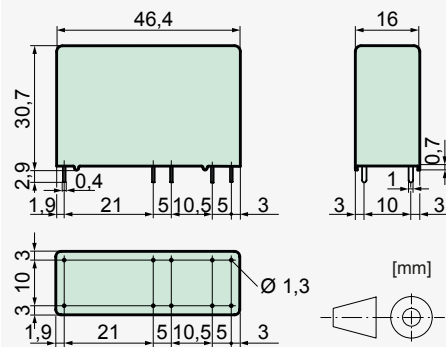

Relay Key Data

- PCB relay with forcibly guided contacts
- Protective separation between coil/control contacts and output contacts (>10 mm), as well as output contacts to each other (>8 mm)
- IEC 61 810-3 Type A
- Contact mounting:
 - SIR312P control contacts 1 NO / 1 NC
 - output contacts 4 NO
 - SIR222P control contacts 2 NC
 - output contacts 4 NO
- Inrush current 60 A / continuous current 12 A
- Nominal coil power 0,75 W
- Holding coil power 0,23 W
- Coil for railway application according EN 50 155 on request

Dimensions



Control contact data

Contact material	AgSnO ₂ + 0,2 µm Au
Rated switching capacity	250 VAC 6 A AC1 1500 VA
Electr. Life AC1(360 S / h)	approx. 100000
Inrush current max.	15 A for 20 ms
Switching voltage range	5 to 250 VDC / VAC
Switching current range*	5 mA to 6 A
Switching capacity range*	60 mW to 1500 W(VA)
Contact resistance (as delivered)	≤100 mΩ / 6 V / 100 mA

Output contact data

Contact material	AgSnO ₂
Rated switching capacity	250 VAC (440 VAC) 12 A AC1 3000 VA
Electr. Life AC1(360 S / h)	approx. 250000
Inrush current max.	60 A for 20 ms
Switching voltage range	5 to 250 VDC (480 VAC)
Switching current range*	10 mA to 12 A
Switching capacity range*	120 mW to 3000 W(VA)
Contact resistance (as delivered)	≤100 mΩ / 6 V / 100 mA

*Guided values

Standard Coils for Direct Current

(other voltages on request)

Nominal voltage VDC	Min. pick-up voltage VDC at 20 °C	Drop-out voltage VDC at 20 °C	Nominal current in mA at 20 °C	Resistance in Ohm at 20 °C
5	≤3,5	≥0,5	151,0	33 ± 10%
12	≤8,4	≥1,2	63,1	190 ± 10%
18	≤12,6	≥1,8	41,6	432 ± 10%
20	≤14,0	≥2,0	37,7	530 ± 10%
24	≤16,8	≥2,4	31,5	760 ± 10%
48	≤33,6	≥4,8	15,7	3050 ± 10%
60	≤42,0	≥6,0	12,5	4800 ± 13%
110	≤77,0	≥11,0	6,8	16000 ± 15%

Circuit Diagram (relay top view)

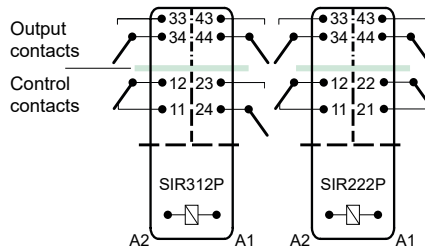

Insulation Data

Basic insulation	at 250 VAC
Air and creepage distance	>4 mm
Test voltage	2500 V / 50 Hz / 1 min
Double or reinforced insulation	at 250 VAC
Air and creepage distance	>8 mm
Test voltage	4000 V / 50 Hz / 1 min
Double or reinforced insulation	at 250 VAC
Air and creepage distance	>10 mm
Test voltage	5000 V / 50 Hz / 1 min
Test voltage contact open	1500 V / 50 Hz / 1 min
Creepage resistance	CTI 250
Pollution degree	2
Overvoltage category	III
Insulation resistance at Up 500 VDC	>100 MΩ

Additional Data

Mechanical endurance	>10 x 10 ⁶ operations
Switching frequency, mechanical	15 Hz
Response time (all NO closed)	typically 15 ms
Drop-out time** (NC closed)	typically 4 ms
Bounce time of NO contact	typically 6 ms
Bounce time of NC contact	typically 12 ms
Shock resistance 16 ms	NO > 17g NC > 7g
Vibration resistance (10-200 Hz)	NO > 10g NC > 4,5g
Resistance to short circuiting control contacts	1000 A SCPD 6 A gG / gL (pre-fuse)
Resistance to short circuiting output contacts	1000 A SCPD 16 A gG / gL (pre-fuse)
Ambient temperature	-40°C to +70°C
Thermal Resistance	55 K / W
Temperature limit for coil	120°C
Weight	approx. 32 g
Mounting position	any
Mounting distance	rec. >5 mm
Test method	A / group assembly
Type of protection	RT II
Solder bath temperature	270°C / 5 s

**without spark suppression

Tests, Regulations, Standards

Approvals	
UL File E188953	Sec. 3
Insulation class IEC 60664-1	250 VAC
Fire protection requirements	UL 94 / V0
Standards IEC 61810-1, IEC 61810-3	

Options, Accessories

Print socket

Product Key

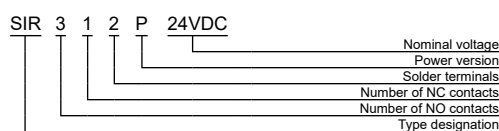

Contact life output contacts DC

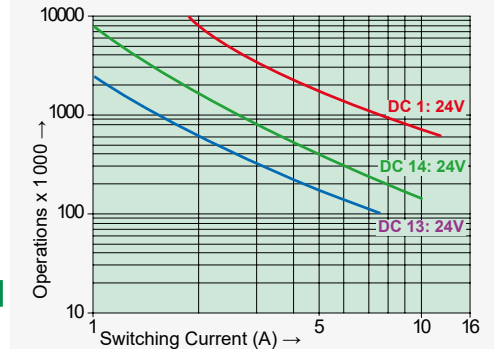

Contact life output contacts AC

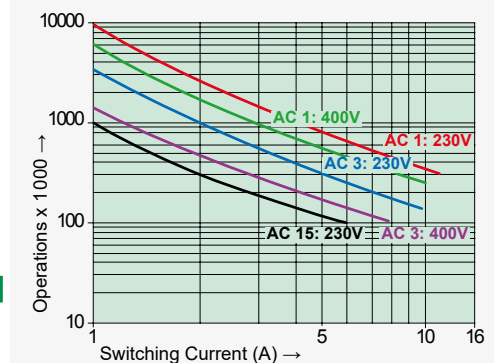

Maximal contact load at AC 1 with 230 V:
2 contacts with 12 A each

Load Limit Curve with Direct Current

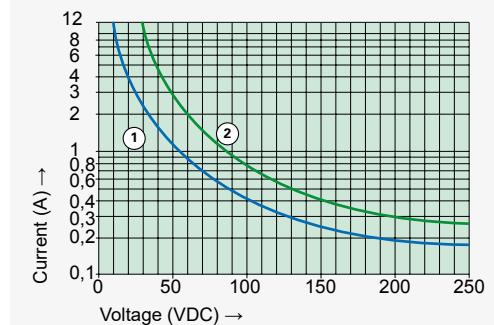

- 1) Inductive load L/R 40 ms
- 2) Resistive load

Excitation Voltage Range

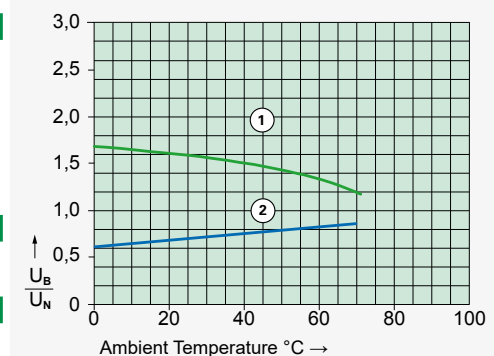

- 1) Max. excitation voltage with contact load: Control contacts ≤2 A, Output Control contacts ≤10 A
- 2) Min. excitation voltage (guaranteed values) without previous operation.